

morrifield Greenhouses



Award Winning Morrifield Greenhouses have been delivering premium quality expert greenhouse solutions since 1980. A trusted name in NZ's gardening industry, providing excellent quality that delivers exceptional value and performance. Designed and manufactured in Southland, our greenhouses not only extend your growing season but also promote faster growth. Tried & tested to withstand New Zealand's harshest weather conditions, including snow, hail and high winds.



Why Choose Morrifield Greenhouses?



NZ's Strongest Greenhouses



Exceptional Sales & Service



Premium quality expert greenhouse solutions



Tried & Tested in NZ's harshest climates



Easiest DIY Kitset Assembly guaranteed



Market leaders since 1980



100% NZ Made



More than 20,000+ happy customers!



Visit our website
morrifield.com



Price List

POLYTHENE TUNNELHOUSES

Tunnelhouse Kit Set includes 100mm x 50mm tanalised timber base.

Urban Junior - 1.8 METRES WIDE

2 METRE

- a) 1 front door, 1 roof vent **\$1,325**
- b) 1 front door, 1 roof vent, 1 rear window **\$1,560**

3 METRE

- a) 1 front door, 1 roof vent **\$1,445**
- b) 1 front door, 1 roof vent, 1 rear window **\$1,680**

4 METRE

- a) 1 front door, 1 roof vent **\$1,550**
- b) 1 front door, 1 roof vent, 1 rear window **\$1,785**
- c) Doors front & rear, 1 roof vent **\$1,880**

Standard Models - 2.35 METRES WIDE

2.5 METRE

- a) 1 front door, 1 roof vent **\$1,400**
- b) 1 front door, 1 roof vent, 1 rear window **\$1,635**

4 METRE

- a) 1 front door, 1 roof vent **\$1,600**
- b) 1 front door, 1 roof vent, 1 rear window **\$1,835**
- c) Doors front & rear, 1 roof vent **\$1,930**

5 METRE

- b) 1 front door, 1 roof vent, 1 rear window **\$2,075**
- c) Doors front & rear, 1 roof vent **\$2,170**

6 METRE

- a) 1 front door, 2 roof vents **\$2,175**
- b) 1 front door, 2 roof vents, 1 rear window **\$2,410**
- c) Doors front & rear, 2 roof vents **\$2,505**

8 METRE

- b) 1 front door, 2 roof vents, 1 rear window **\$2,695**
- c) Doors front & rear, 2 roof vents **\$2,790**

10 METRE

- c) Doors front & rear, 3 roof vents **\$3,375**

ACCESSORIES

Screen Door Kit **\$235.00**

Ventilation

Window Kit **\$235.00**
Door Kit **\$330.00**

High Wind Bracing **\$100.00**

Irrigation Kits

UJ2M **\$69.95**
2.5M / UJ3M **\$86.95**
4M / 3.6M / UJ4M **\$99.95**
5M / 4.8M **\$119.95**
6M **\$149.95**
8M / 8.4M / 7.2M **\$210.00**
10M / 9.6M **\$245.00**

Greenhouse Shelving Workstation

2 Tier **\$249.95**
3 Tier **\$339.95**

Shade Covers

2 Metre **\$139.95**
4 Metre **\$189.95**

Please contact us for freight/courier prices for replacement parts and accessories as these may differ due to size and region.



Urban Junior 2, 3 & 4 metre

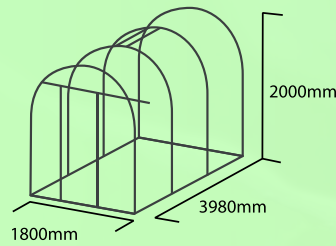
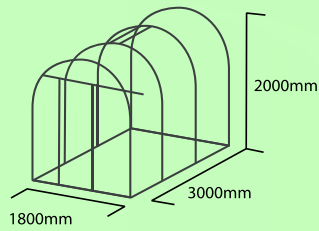
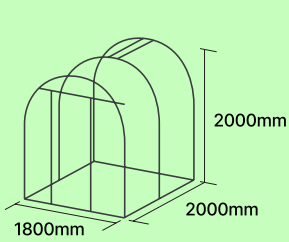

2.5 metre A

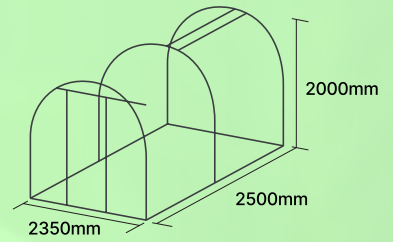

4 metre B

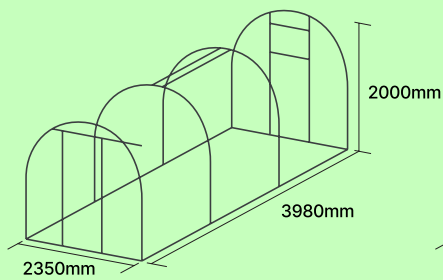

5 metre B

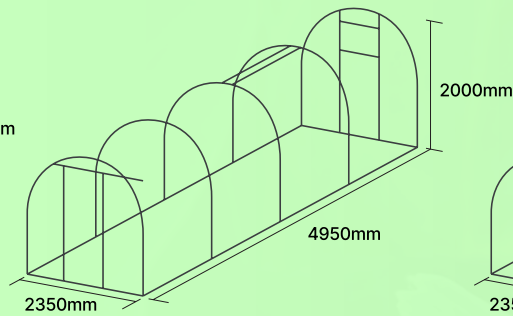

6 metre B

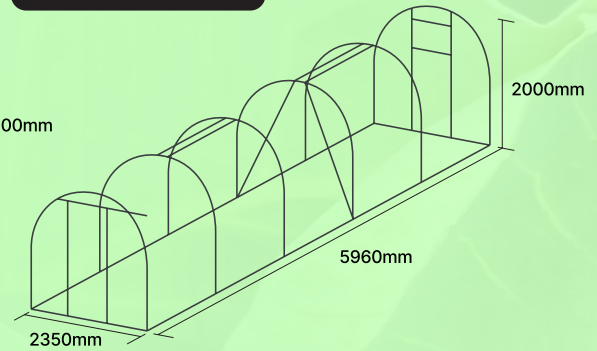

8 metre B

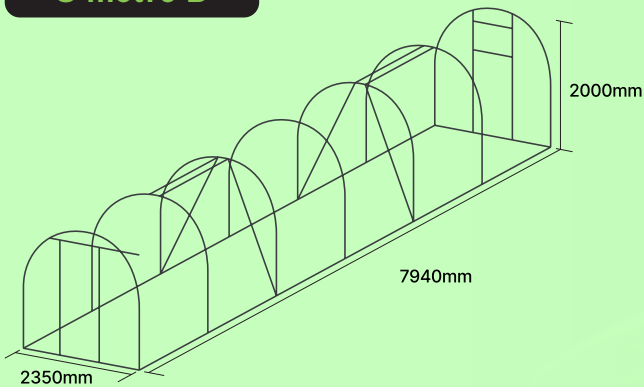

10 metre C

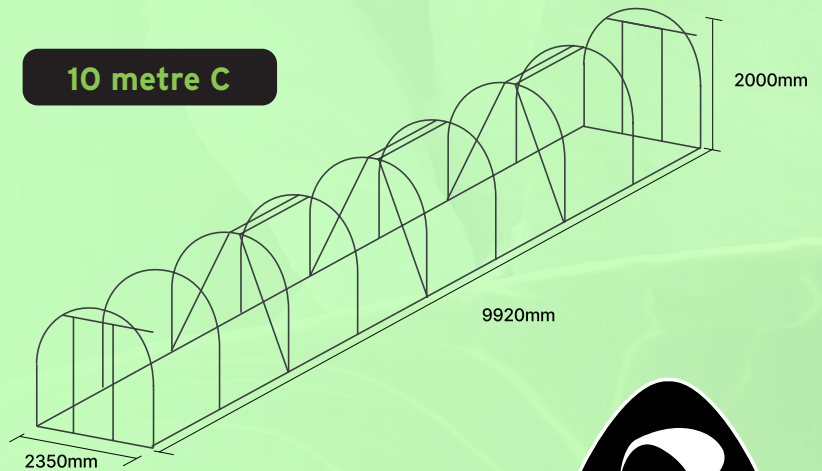

(Measurements are external base sizes)



Replacement Polythene Covers

URBAN JUNIOR

2 metre	\$255.00
3 metre	\$340.00
4 metre	\$385.00

STANDARD MODELS

2.5 metre	\$290.00
4 metre	\$390.00
5 metre	\$450.00
6 metre	\$510.00
8 metre	\$640.00
10 metre	\$770.00



crop protection tunnel houses

Price List

CROP TUNNELHOUSES

Tunnelhouse Kit Set includes 100mm x 50mm tanalised timber base.

Urban Junior - 1.8 METRES WIDE

2 METRE

a) 1 front door **\$1,520**

3 METRE

a) 1 front door **\$1,640**

4 METRE

a) 1 front door **\$1,770**

Standard Models - 2.35 METRES WIDE

2.5 METRE

a) 1 front door **\$1,600**

4 METRE

a) 1 front door **\$1,770**

5 METRE

a) 1 front door **\$1,950**

6 METRE

a) 1 front door **\$2,110**
c) 1 door front and rear **\$2,480**

8 METRE

a) 1 front door **\$2,320**
c) 1 door front and rear **\$2,690**

10 METRE

a) 1 front door **\$2,660**
c) 1 door front and rear **\$3,030**

Replacement Crop Protection Covers

URBAN JUNIOR - 1.8 METRES WIDE

2 METRE **\$395**
3 METRE **\$460**
4 METRE **\$520**

STANDARD MODELS - 2.35 METRES WIDE

2.5 METRE **\$410**
4 METRE **\$540**
5 METRE **\$620**
6 METRE **\$730**
8 METRE **\$860**
10 METRE **\$970**

morrifield

CROP PROTECTION TUNNELHOUSES



Protect your Summer crops.

Keep out the white butterfly and birds.

30% white shade/windbreak cover.

Allow natural watering

Fully fabricated crop cover with 4 year warranty against UV breakdown.



Your local stockist is:

210 Clyde Street,
West Invercagill 9810

Phone: 03 214 4262

Email: info@morrifield.com

www.morrifield.com

 @morrifieldtunnelhouses

 @morrifieldtunnelhouses



twinwall greenhouses

polycarbonate

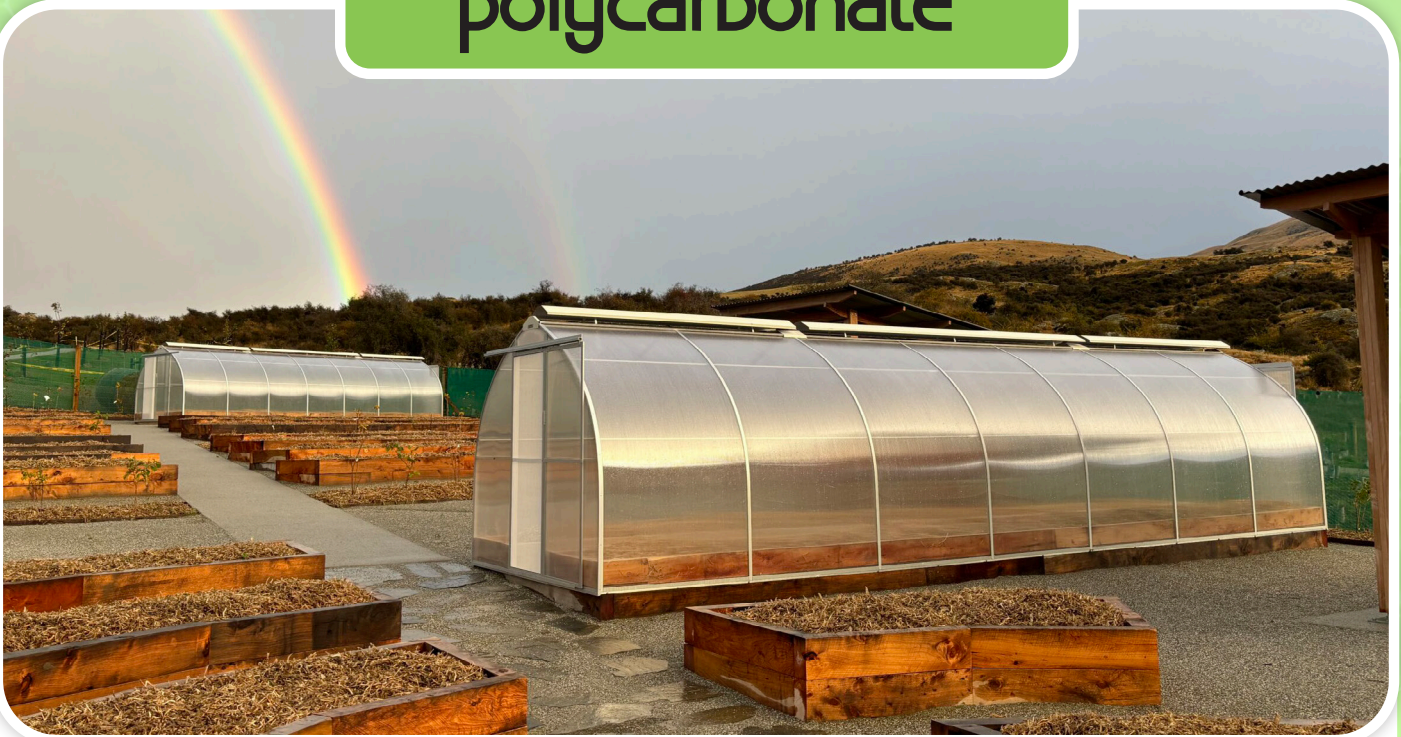









NZ Made Premium Quality Greenhouses.

Experience the strength and reliability of New Zealand's strongest polycarbonate greenhouses. Protect your garden with a trusted brand that's built to last!



Why Choose Morrifield Greenhouses?

-  Promote faster growth.
-  Extend your growing season.
-  Be more self-sustainable.
-  Save \$\$\$; grow your own.
-  Garden in all weather.
-  Fresh, organic, home grown produce.
-  Range of sizes and ventilation options.
-  Expert garden advice and tips.



twinwall greenhouses

Price List

POLYCARBONATE GREENHOUSES

2.4 METRES WIDE

1.2 METRE

Polycarbonate & Screen Door, full length roof vent **\$3,110**
 150mm x 50mm Tanalised Timber Base **\$150**
(Overall timber base measurement 1245mm)

2.5 METRE

Polycarbonate & Screen Door, full length roof vent **\$3,840**
 150mm x 50mm Tanalised Timber Base **\$210**
(Overall timber base measurement 2470mm)

3.6 METRE

Polycarbonate & Screen Door, full length roof vent **\$4,570**
 Polycarbonate & Screen Doors front and rear, full length roof vent **\$5,220**
 150mm x 50mm Tanalised Timber Base **\$270**
(Overall timber base measurement 3695mm)

4.8 METRE

Polycarbonate & Screen Door, full length roof vent **\$5,300**
 Polycarbonate & Screen Doors front and rear, full length roof vent **\$5,950**
 150mm x 50mm Tanalised Timber Base **\$290**
(Overall timber base measurement 4920mm)

6.0 METRE

Polycarbonate & Screen Doors front and rear, full length roof vent **\$6,695**
 150mm x 50mm Tanalised Timber Base **\$350**
(Overall timber base measurement 6145mm)

7.2 METRE

Polycarbonate & Screen Doors front and rear, full length roof vent **\$7,420**
 150mm x 50mm Tanalised Timber Base **\$390**
(Overall timber base measurement 7370mm)

8.4 METRE

Polycarbonate & Screen Doors front and rear, full length roof vent **\$8,155**
 150mm x 50mm Tanalised Timber Base **\$420**
(Overall timber base measurement 8595mm)

9.6 METRE

Polycarbonate & Screen Doors front and rear, full length roof vent **\$8,890**
 150mm x 50mm Tanalised Timber Base **\$470**
(Overall timber base measurement 9820mm)

Freight not included. All freight P.O.A.



morrifield

POLYCARBONATE GREENHOUSES



- Featuring 6mm twinwall polycarbonate, acrylic coated and 15 year UV Warranty.



- Curved sheeting which gives maximum strength.

- NZ's Strongest Polycarbonate Greenhouse.



- Partially assembled for easier installation.

- Full length roof vent for better ventilation.

- Polycarbonate and Screen doors.



- Better heat retention and filters sunlight.

